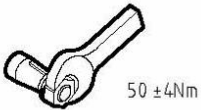
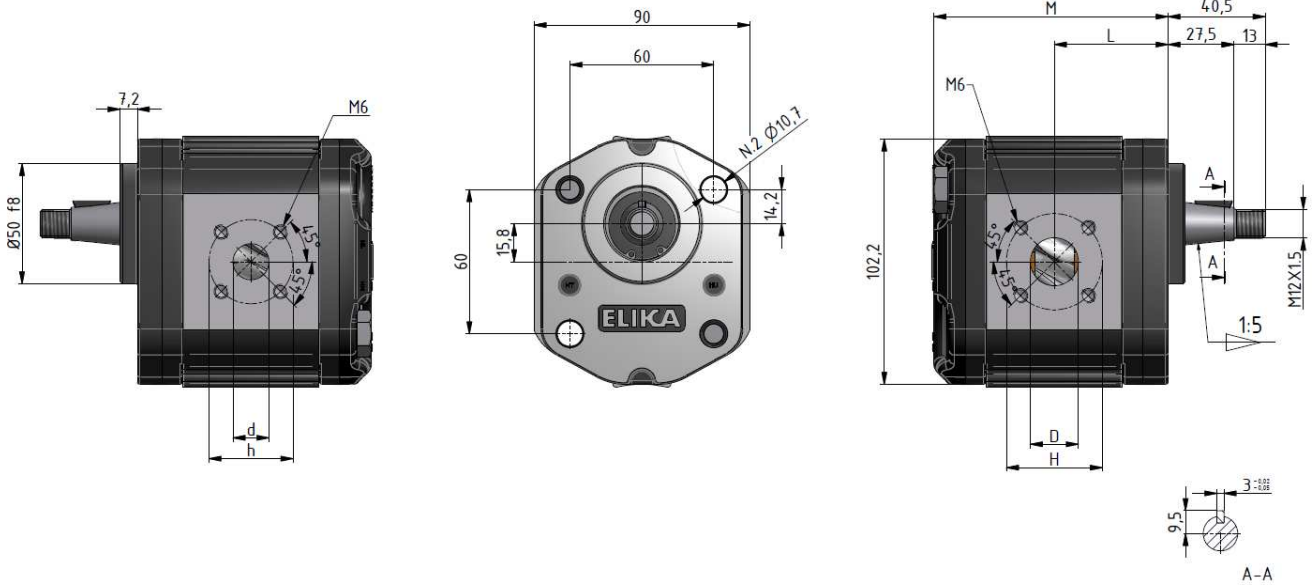

ELI2BK2

Outlet
Inlet

Pump Type	Displacement [cm ³ /rev]	Flow at 1500 rpm [l/min]	Operating pressures			Rotation speed		Noise at 1500 rpm *		Dimensions					
			P1 Max cont. [bar]	P2 Max intermittent [bar]	P3 Max peak [bar]	Minimum speed [rpm]	Maximum speed [rpm]	On recirc. [dBA]	at P1 [dBA]	L [mm]	M [mm]	D [mm]	H [mm]	d [mm]	H [mm]
ELI2BK2-D-7.0	7.0	10.5	280	295	310	300	4000	47	51	45.2	93.2	15	40	15	35
ELI2BK2-D-8.2	8.2	12.3	280	295	310	300	4000	47	52	46.2	95.2	15	40	15	35
ELI2BK2-D-9.6	9.6	14.5	280	295	310	300	4000	48	54	47.5	97.7	20	40	15	35
ELI2BK2-D-11.4	11.4	17.1	280	295	310	300	4000	48	55	49.0	100.7	20	40	15	35
ELI2BK2-D-14.0	14.0	21.0	260	275	290	300	4000	49	55	51.2	105.2	20	40	15	35
ELI2BK2-D-16.1	16.1	24.1	260	275	290	300	4000	49	56	53.0	108.7	20	40	15	35
ELI2BK2-D-17.8	17.8	26.7	260	275	290	300	4000	49	57	54.5	111.7	20	40	15	35
ELI2BK2-D-21.0	21.0	31.5	230	245	260	200	3500	49	57	57.2	117.2	20	40	15	35
ELI2BK2-D-23.7	23.7	35.5	230	245	260	200	3200	50	57	59.5	121.7	20	40	15	35
ELI2BK2-D-25.7	25.7	38.6	210	225	240	200	3000	50	57	61.2	125.2	20	40	15	35
ELI2BK2-D-28.0	28.0	42.1	200	215	230	200	2600	50	58	63.2	129.2	20	40	15	35
ELI2BK2-D-35.0	35.1	52.6	150	165	180	200	2200	50	58	69.2	141.2	20	40	15	35

Accessories supplied with the standard pump: woodruff key (code 522055), M12x1.5 hexagonal nut (code 523016), washer (code 523005). Standard ports: M6 threads depth 13 mm. To mount the pump: n°2 M10 screws with a torque wrench setting fixed at 46±4 Nm. Please strictly follow assembly and use indications given in this catalogue for top performance and longer life of the ELI Marzocchi series. It is also very important to equip the hydraulic system with a proper filtering unit.